

Amazon 2: Reducing Downtime on SmartPac Machines

Murad El Asad, Samantha Lu, Menghao Wang, Saifallah Ghazi, Taufic Andonie

IE 43100 Fall 2022

This project is focused on reducing downtime caused by the NAS Retrofit (Version 3.5), a semi-automatic SmartPac machine that Amazon uses for packaging mailers. This project is aimed at not only eliminating a bottleneck in the distribution process but will also affect their Reliability Maintenance Engineering (RME) team as they consistently invest labor into fixing the machines. The effects of the delays in packaging the products lead to increased expedited shipping costs for Amazon to get the product to the customer on time despite the delay. To be successful, this project requires a big-picture point of view as our changes will affect hundreds of SmartPac machines in various fulfillment centers worldwide.

This project is sponsored by Amazon



Project Background

Problem: Amazon's smart packaging machines have been exhibiting a cutting failure when dealing with 2 types of bag materials that are fed into the SmartPac machines, and the failure is more likely to occur when cutting the thinner material bags.

Goal of Project: Research and test varied materials that could be used to manufacture a more effective and reliable blade for this machine, as well as to give advice about the structural design of the blades.

Blade Research: The team visited the Amazon Fulfillment Center MDW7 on October 15th to better understand what the machine does and how it operates. A defective blade was given to the team and used to conduct our research. The different materials researched are Damascus steel, Aluminum, A2, 304, and 316 stainless steel. The best material is the one that can withstand the heating element, provide even heating to the cutting edge of the blade, and would not need constant replacing (which causes downtime and requires maintenance labor).

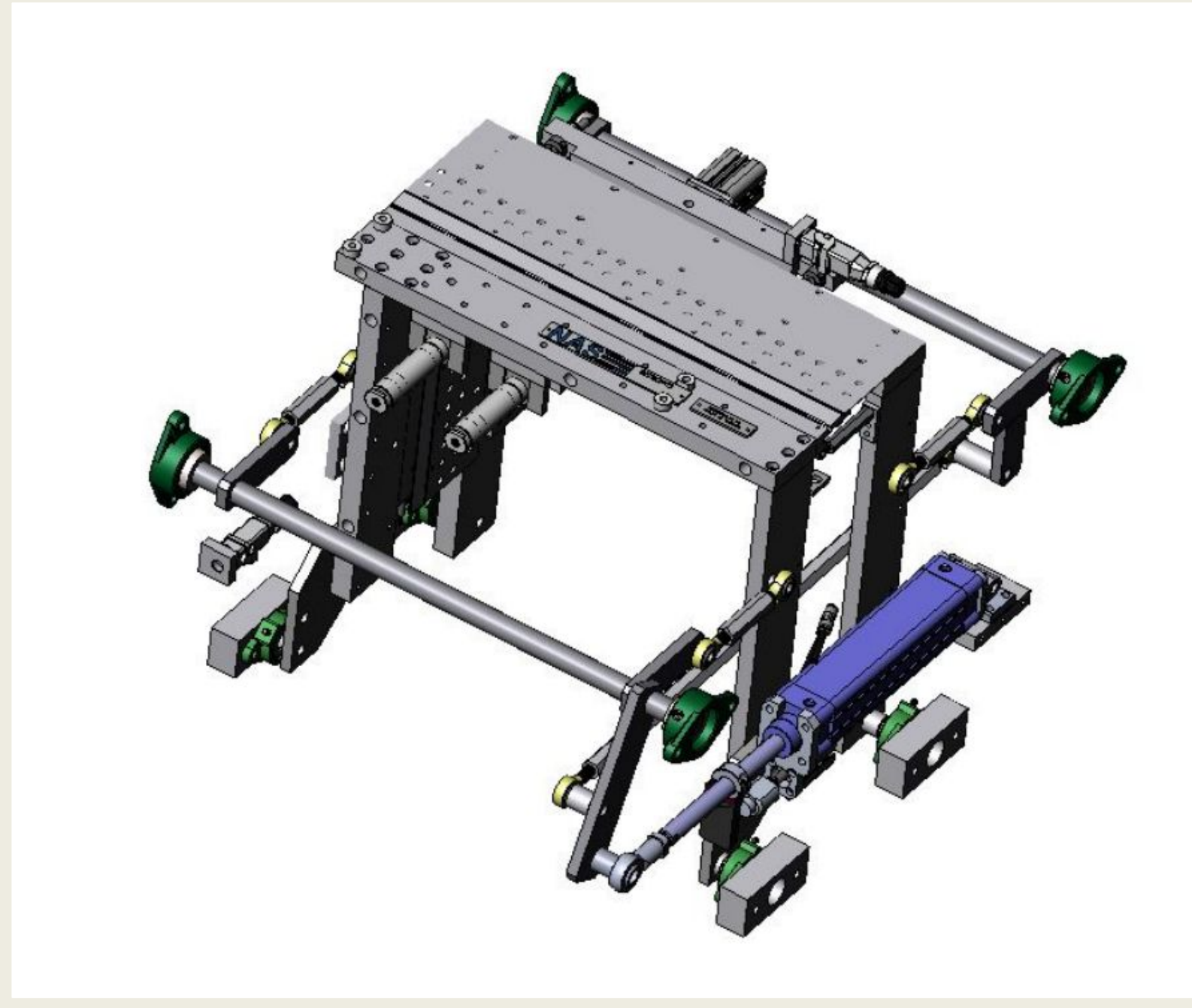

Figure 1: NAS Retrofit Package Cutting Machine

Results

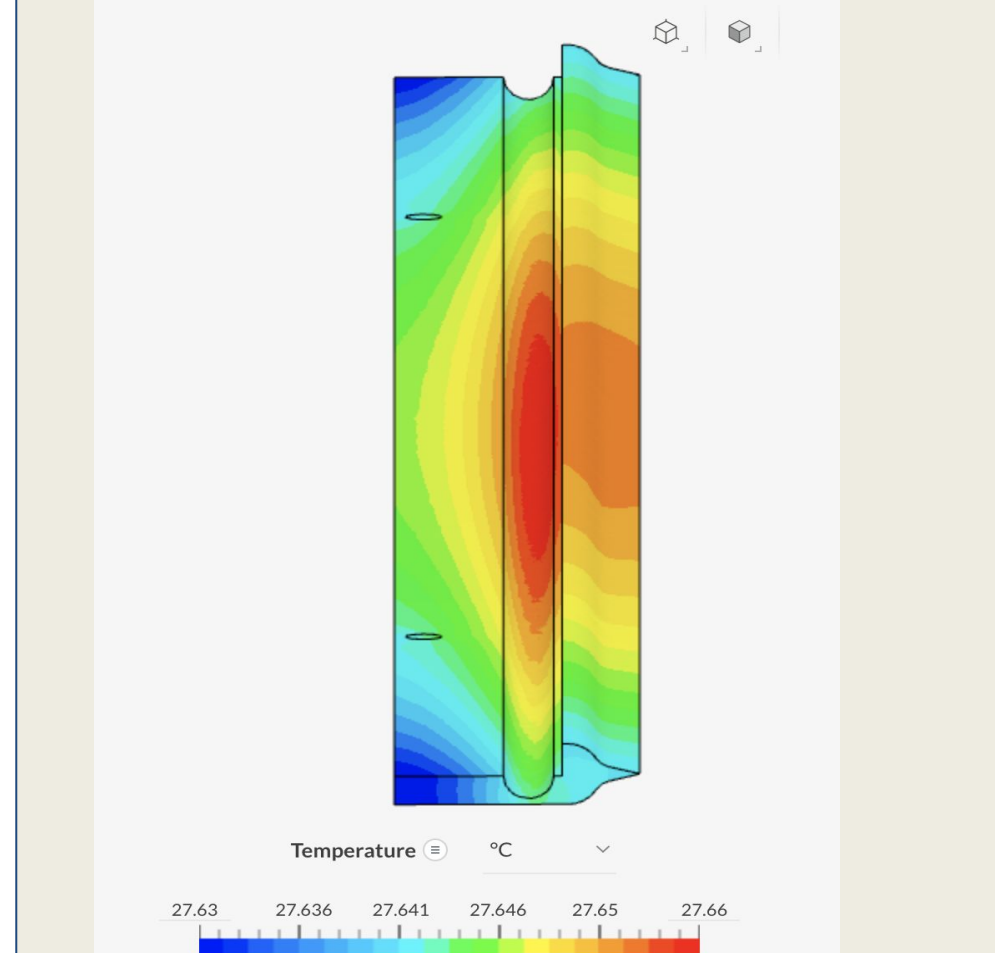

Figure 4: Aluminum Redesigned Blade

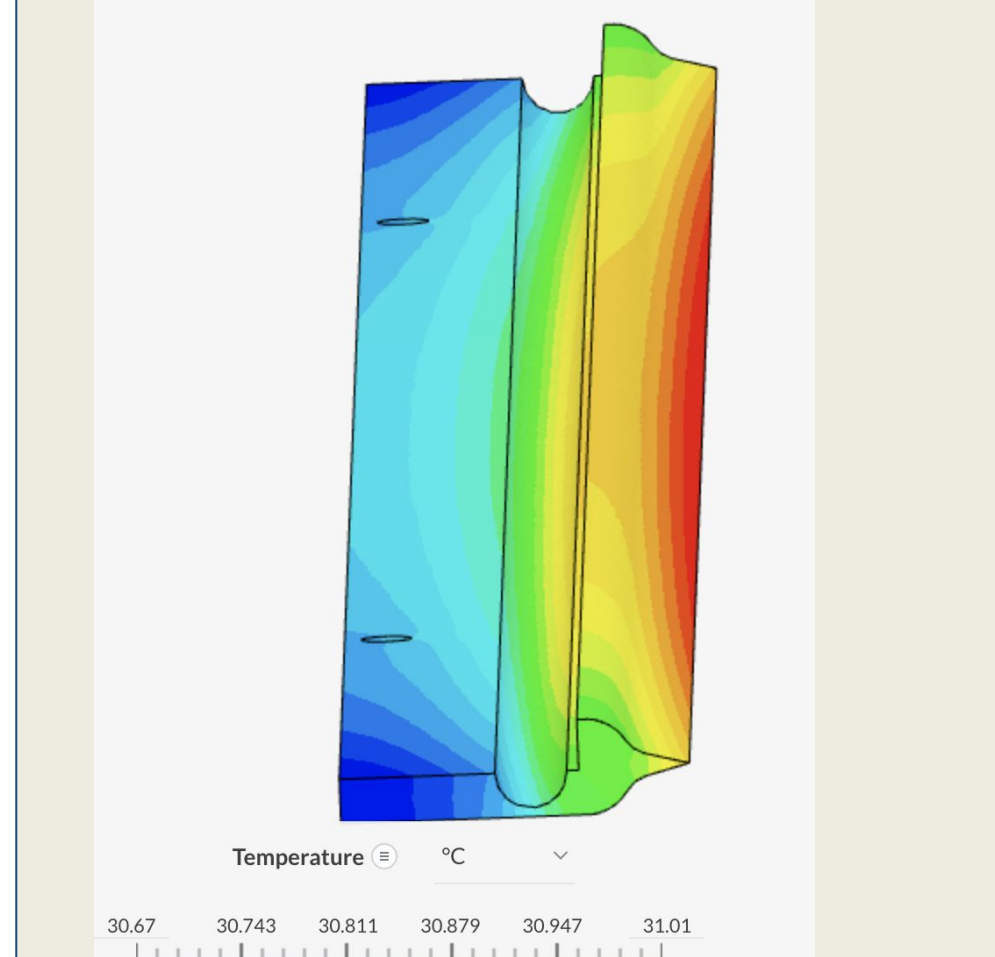

Figure 5: Steel Redesigned Blade

The heat diffusion equation at steady state says that materials with higher thermal conductivity allow more heat to be transported via convection from the hottest point on the blade to the coldest point. Looking at the thermal conductivity for the two tested materials: Aluminum is 235 W/mK and Steel is 60 W/mK. Additionally, with lower thermal conductivity, there is less heat transfer. In our boundary conditions, the hottest point of the blade is the groove. Another boundary condition used was the convections boundary, which exposes the coldest point: the ambient.

Recommendation

The thermal resistance for aluminum is less than thermal resistance for steel. The equation for thermal resistance is the affected length over the affected area multiplied the affected thermal conductivity of the material

$$\frac{R_A}{R_S} < 1 \quad R = \frac{L}{kA}$$

$$\frac{\Delta T_A}{\Delta T_S} < 1 \Rightarrow T_{S,S} > T_{S,A}$$

T_A : Temp of Aluminum
 T_S : Temp of Steel
 R_A : Thermal cond. Res. for Aluminum
 R_S : Thermal cond. Res. for Steel
 $T_{S,A}$: Surface temp of Aluminum
 $T_{S,S}$: Surface temp of Steel
 T_{∞} : Ambient temp (26°)

Figure 8: Mathematical explanation for choosing Steel

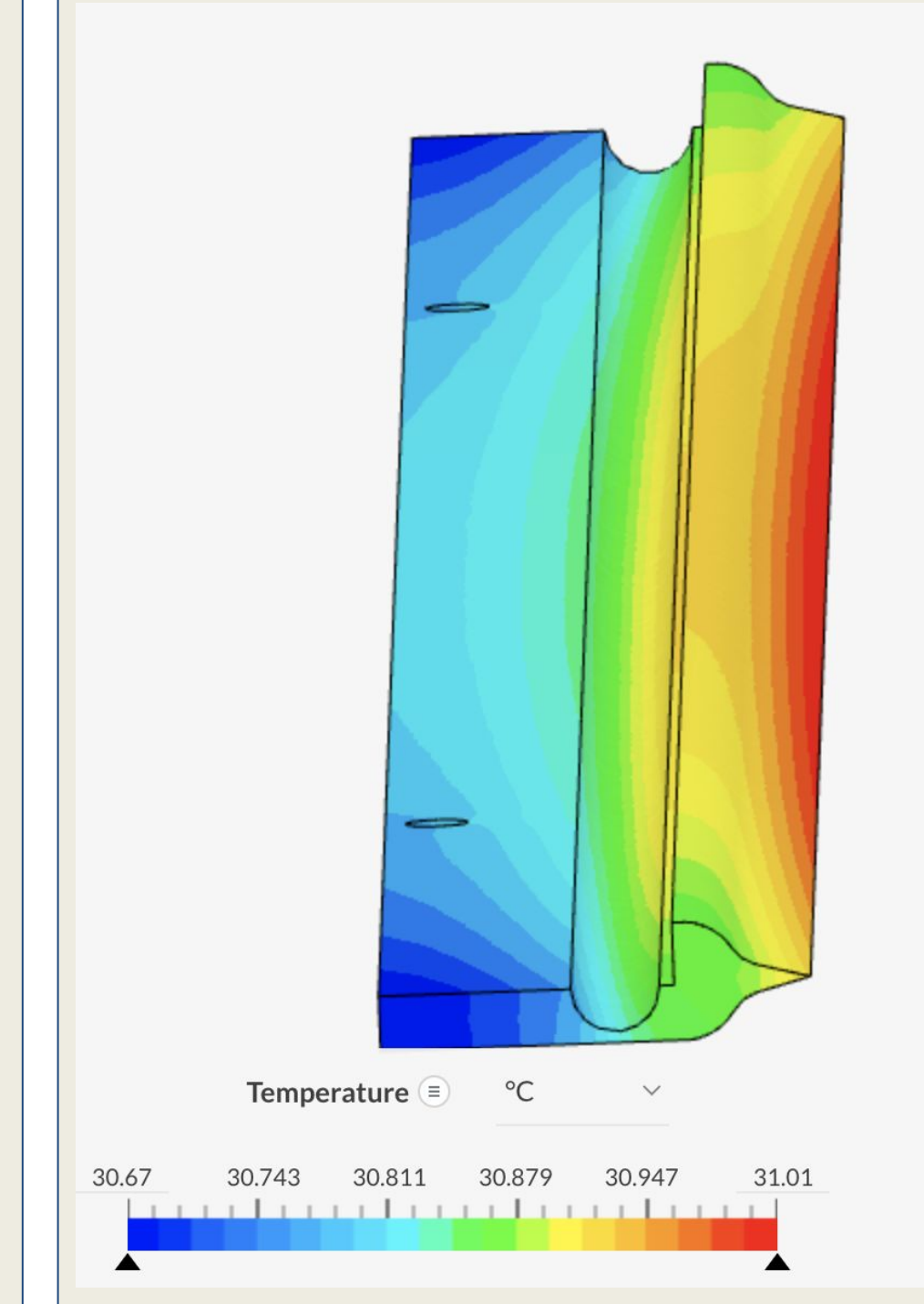

Figure 7: Final Recommendation

Aluminum's maximum temperature is 27.66 C, and its minimum is 27.63 C. The steel's maximum temperature is 31.01 C, and minimum is 30.67 C. The hotter part in steel is hotter than the hottest point in aluminum, and the colder part in aluminum is colder than the coldest point in steel. The thermal conductivity resistance is lower for Aluminum, hence the thermal resistance is lower. The surface temperature of the steel is greater than the surface temperature of aluminum, and it's preferred that the blade has a hotter temperature to melt, and thus steel is preferred. Additionally, it can be seen in Figures 4 and 5 that Steel provides more heating to the cutting edge than the Aluminum. Therefore, a new design of the blade made of steel is recommended.

Current State

- Aluminum:**
- Cons:
 - Soft metal
 - Bends easily
 - Details regarding cutting:
 - Malleable metal and ductile
 - High thermal conductivity
 - Has excellent corrosion resistance
 - Can be easily casted, machined and formed.
 - Temperature:
 - Depends on the alloy, but typically between 825° and 980°F

- Steel:**
- Cons:
 - Soft metal
 - May lose its sharpness quickly.
 - Temperature:
 - The oxidation resistance in steel is good in intermittent service up to 870°C
 - Continuous service up to 925°C
 - Resistance to carbide precipitation

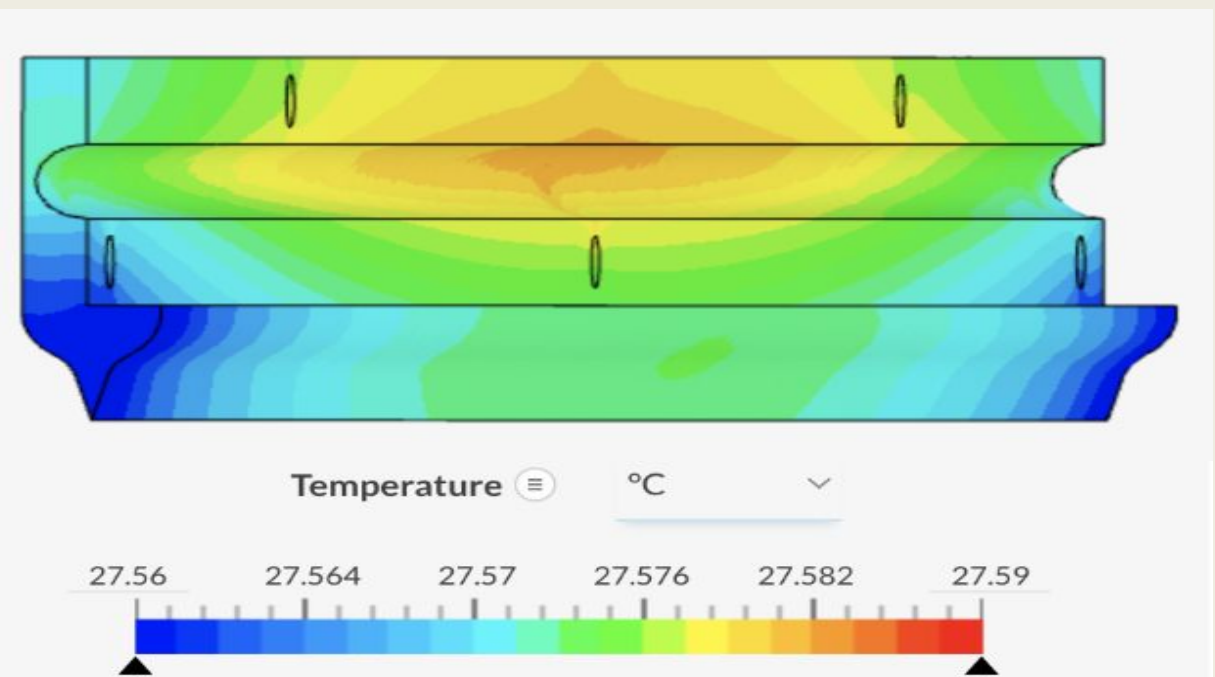

Figure 2: Aluminum Original Blade

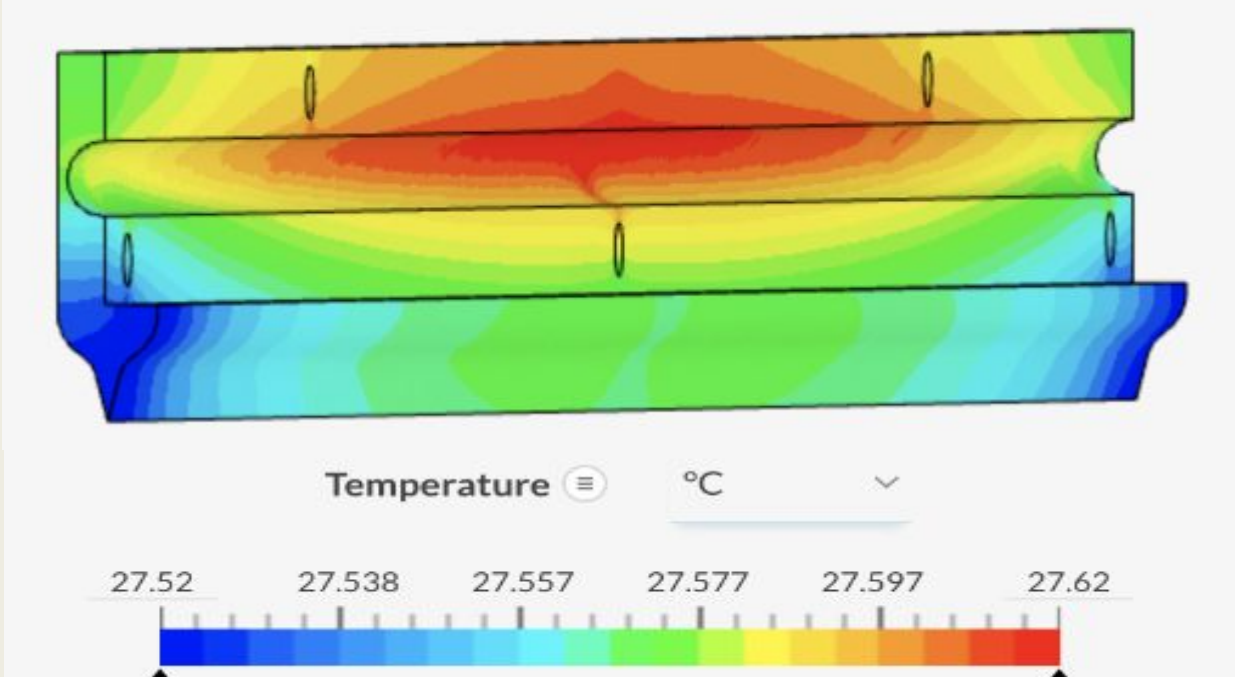

Figure 3: Steel Original Blade

Discussion

Changes to Project Scope: When first presented with this project, we were asked to analyze, design and implement an improved blade for our customer. Upon reflection of our time remaining, we spoke to our customer and discussed changing the scope to performing material research, designing an AutoCAD model of the blade, and using heat transfer software to perform virtual testing with varied materials to determine our recommended blade. Below is our updated Gantt chart reflecting the new project scope.

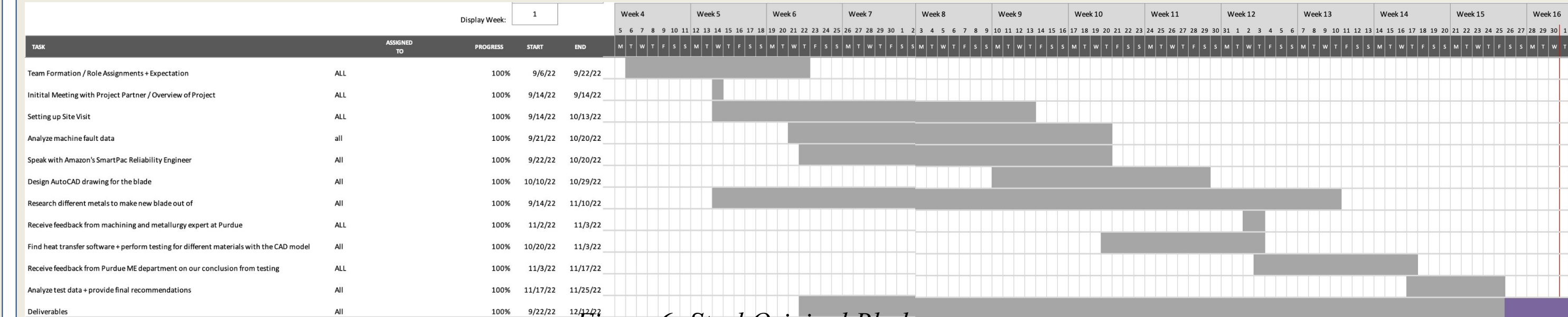

Figure 6: Steel Original Blade

Methods and Materials: Upon updating the project scope, our team began creating an AutoCAD model of the blade given to us by Amazon. Once the blade was designed, we began investigation into different metal materials that would have properties ideal for heating as well as looked into thermal analysis softwares. We reached out to a Senior Mechanical Engineering Ph.D. student for help with using the thermal analysis software SimScale. With guidance from the Ph.D. student, we were able to perform Steady State thermal analysis on the current blade as well as gain new knowledge about Heat and Mass Transfer that allowed us to see the issue with the current blade's geometry. From there, we used the theory taught to us by the Ph.D. student to alter the geometry of the current blade to allow for better heating at the cutting edge of the blade. The comparison in heat distribution maps between the current blade and proposed redesigned one served as a Proof-of-Concept that the redesigned blade would heat the cutting edge better.

Conclusion

After performing material research and thermal analyses of four different blade designs (2 materials and 2 geometries), our final recommendation to Amazon, as depicted in Figure 7, is to implement redesigned blade (that places the heating element closer to the cutting edge) made out of Steel. The idea for the geometry of the new blade is supported by basic heat transfer principles and the choice of material is backed by our metallurgy research. The next steps for this project would be to have a machinist create the recommended blade, using our AutoCAD drawing, so that Amazon can begin testing the blade on the SmartPac machines.

References

Amazon jobs hiring now - hourly & Shift jobs @ Amazon. (n.d.). Retrieved September 27, 2022, from <https://hiring.amazon.com/>

Barr, C., & Claude, J. (2021). Let's save the Amazon: Why we must protect our planet. Amazon. Retrieved September 29, 2022, from <https://hiring.amazon.com/why-amazon/shifts-and-schedules#/Schedules>

PACJacket Home. PAC Jacket. (2021, July 26). Retrieved September 29, 2022, from <https://www.pacjacket.com/>

Wang, J. (2021, November 1). Amazon warehouse in Markham now up and running. WGN. Retrieved September 29, 2022, from <https://wgntv.com/news/amazon-warehouse-in-markham-now-up-and-running/>

YouTube. (2015). PACjacket Smart Automated Packaging System by Pac Worldwide. YouTube. Retrieved September 27, 2022, from https://www.youtube.com/watch?v=iRmx2L8Z38E&ab_channel=PACWorldwideCorporation